

LEAD WIRE LENGTH 11.81 (300)  
UL3266 AWG No.20

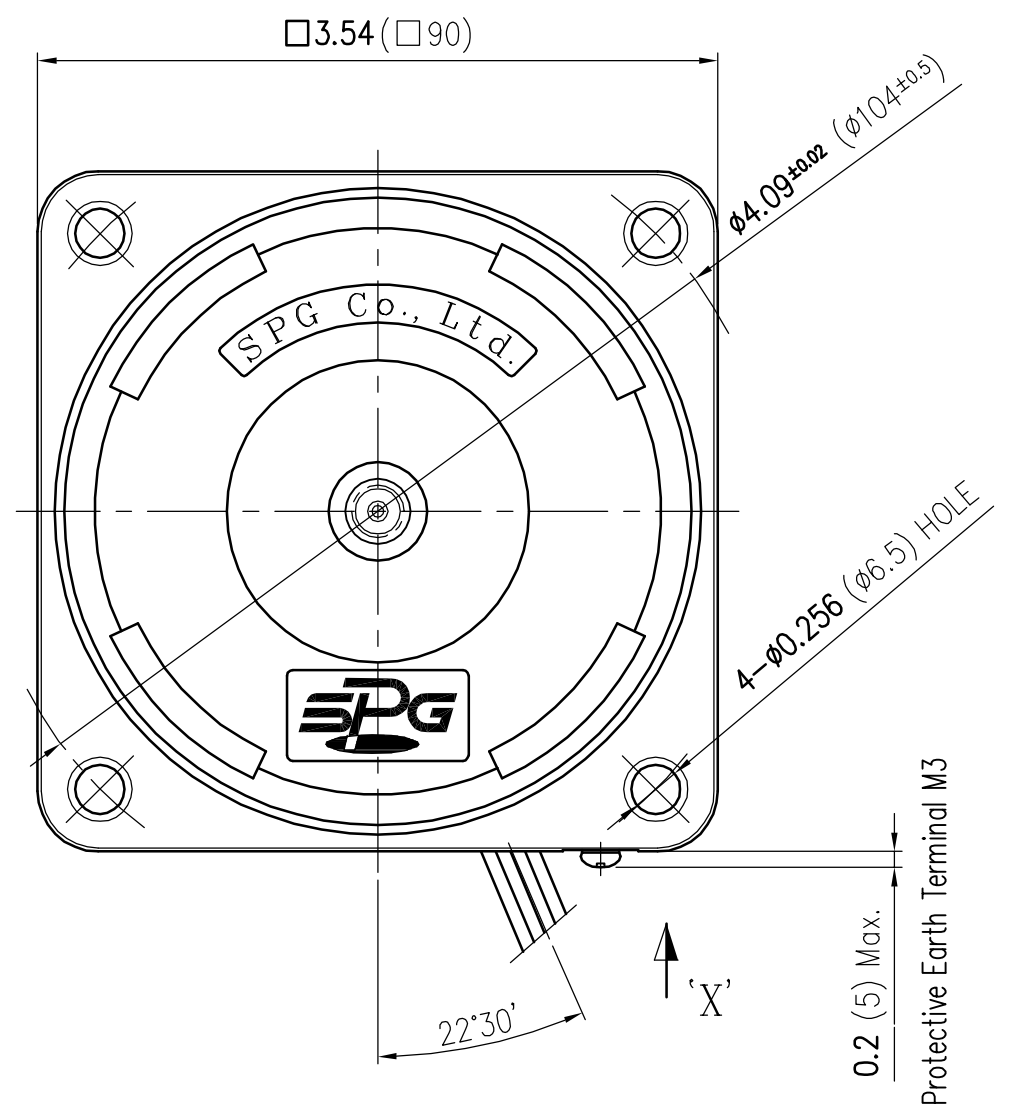

▽ SCHEMATIC

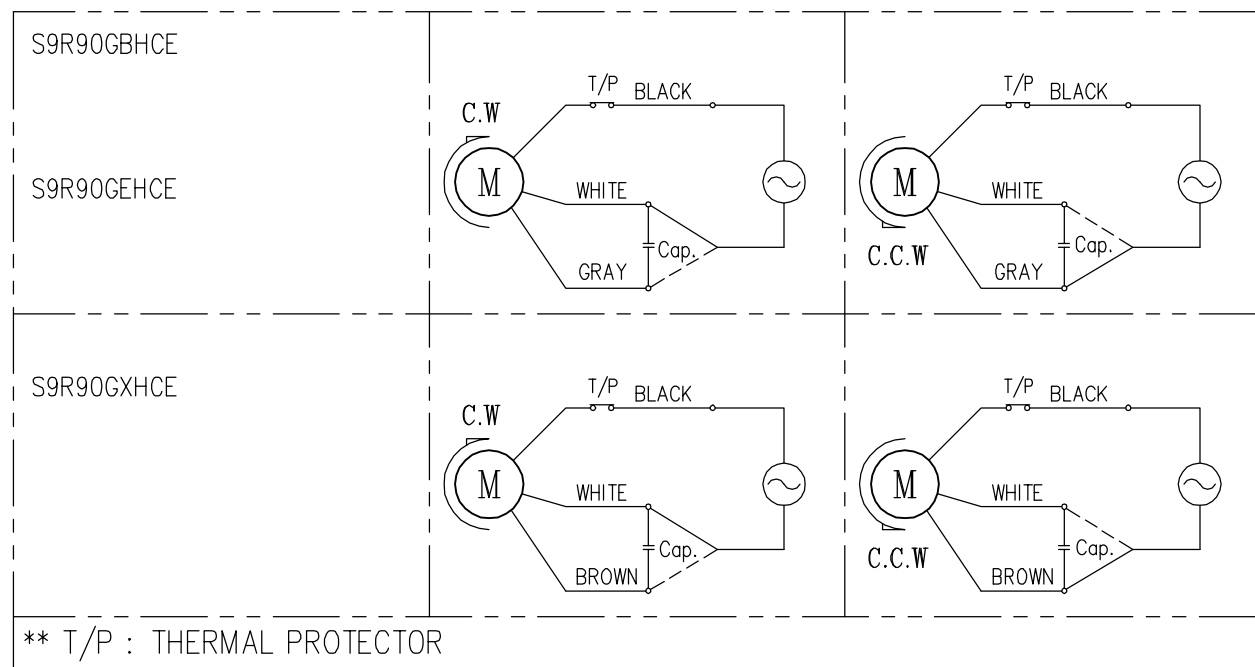

\*\* T/P : THERMAL PROTECTOR

NOTE

1. TYPE : AC INDUCTION MOTOR (REVERSIBLE TYPE)
2. ROTATION : VIEWED FROM SHAFT END C.W. or C.C.W.
3. END PLAY : 0.02inch (0.5mm) Max.

VIEW 'X'

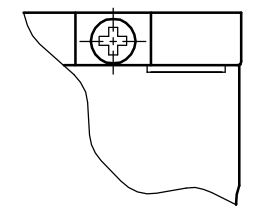

△									
△									
△									
	DATE	SIGN	NOTE			REVISION			
	MATERIAL	SURFACE FINISH		SCALE	1/1	TOLERANCE	± 0.04 [1.0]		
	DRAWN	DESIGN	CHECK	APPR.	MOTOR ASS'Y				
	Y.M. WON	B.Y. JEONG	S.M. KIM	NAME					
	2011.06.24	2011.06.24	2011.06.24		S9R90G □ HCE				
	SPG Co., Ltd.			DATE		DWG NO.			